

USER MANUAL

# Cooling counters

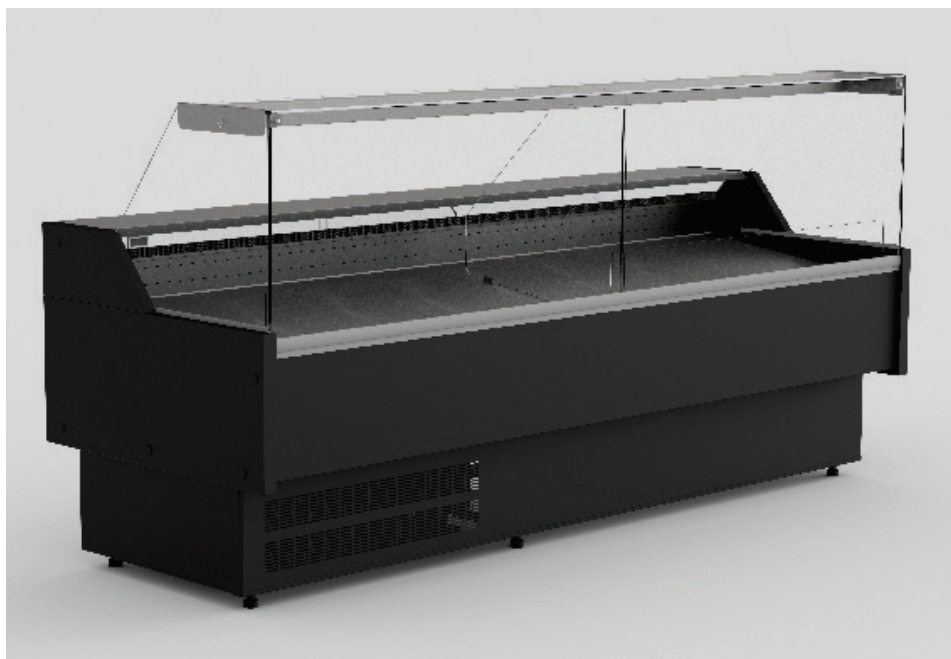

USER MANUAL

ENG

---

# COOLING COUNTERS

## General information

### **1. General Information**

The Food Display Counter is a universal appliance for exposition and shortterm storage of various kinds of foods in lower temperatures. It ensures prolonged freshness and enables longer storage. The Counter is illuminated and the lamps provide special light structure and enhance the attractiveness of displayed products.

The Counter has two cooled useful compartments:

- a glassed compartment for displaying foods, and
- a compartment for storing foods.

Temperature in the compartment ranges from +1°C to +10°C.

The appliance has been awarded the “Certificate allowing the manufacturer to label its product with the safety mark” by the PREDOM-OBR Research & Development Center and at the same time comply with standard PN-EN 60335-2-89:2003

Household and similar electrical appliances - Safety - Part 2-89: Particular requirements for commercial refrigerating appliances with an incorporated or remote refrigerant condensing unit or compressor” at the ambient temperature of 25°C±1°C and humidity of 60%±5%

---

## **2. Technical Characteristic**

Body of the Food Display Counter is made of galvanized steel sheet that is powderlacquered, or of stainless-steel sheet, and placed on a shape steel footing.

The inside lining is made of sheet aluminum or acid-resistant sheet. The body is insulated with a layer of foamed polyurethane.

In the bottom part of the appliance there is an energy-saving refrigerating unit with its automatic control unit.

The appliance's operation is based on a single-stage compressor refrigerating cycle.

The appliance is protected from negative impact of lightning strokes by means of a grounding system. The Food Display Counter must be connected to a grounded socket only.

Note: Manufacturer reserves the right to modify the constructional solutions and apply different subassemblies that on no account will influence the appliance's parameters.

## **3. Electrical installation**

The Food Display Counter should be supplied from a separate low-voltage circuit.

The electrical installation is provided with a lightning protection system applying the grounding solutions .

Prior to starting the appliance make sure the supply voltage is adequate and complies with the refrigerating unit's voltage. Ensure an adequate 10 A fuse-element has been installed in front of the plug.

*The electrical installation must be performed by an authorized electrician. Following repairs or overhauls ensure the electrical connections are made in compliance with the enclosed circuit diagram.*

---

## **4. Appliance's operation**

### **4.1. Locating and installing the unit**

The Food Display Counter should operate in a place that provides good air circulation and is free from direct sunlight, away from any heat sources, and it should be placed so to provide direct access to the plug of the feeder cable.

Ensure that the inlet and outlet openings in the refrigerating unit's chamber (perforations in the lower part of the FDC) are never blanked off so that to provide a free air circulation to cool the refrigerating unit.

If the Food Display Counter is appropriately leveled, it is possible to obtain noise-free operation and proper outflow of water when the Counter is defrosted.

The appliance must be connected to a grounded socket, see Section 3.

### **4.2. Commissioning and start-up**



The appliance is turned on and off with the switch on the thermostat panel in the lower part of the display. To turn the lighting on, use the separate lighting button. After the appliance is connected to the power supply and turned on, wait until the FDC has cooled down before placing any food in there. As soon as the required temperature is reached, the temperature controller turns the refrigerating unit off. Only then can the FDC be filled with goods and fully utilized. The Food Display Counter has been checked and regulated in-house and operates properly in the ambient temperature from  $+10^{\circ}\text{C}$  to  $+25^{\circ}\text{C} \pm 1^{\circ}\text{C}$  and the air humidity not exceeding  $60 \pm 5\%$ .

When operating failure-free, the refrigerating unit makes breaks, i.e. after running for a few (up to twenty) minutes, the refrigerating unit stops for a few (up to twenty) minutes. How long are the running and break times depends on such factors as: the ambient temperature, volume and type of products placed inside the FDC and volume of frosting on the evaporator.

If the Food Display Counter fails to reach the required temperature (within the range of  $+1^{\circ}\text{C}$  to  $+10^{\circ}\text{C}$ ), it is possible to adjust its operation.

---

In order to change the thermostat's settings push the  button. The button's green LED turns on and the panel displays the recently programmed temperature.

- The temperature is adjusted by means of the   buttons. By pushing and holding any of the buttons you can respectively fast rewind or fast forward the settings.

- After selecting the desired temperature push the  button again.

The green LED then turns off and the temperature controller leaves the programming mode and starts the new program.

If the  button is not pushed at the end to confirm the new setting, the thermostat will automatically leave the programming mode after approx. 5 seconds from the moment any button is pushed the last time. The new value of temperature will not be saved and applied.

It is not always advisable to set the working temperatures to low values; overloading the Food Display Counter with goods will result in continuous operation of the refrigerating unit and thus dew deposition on glass panes. Dew deposition on glass panes can be observed also if the Unit operates in the ambient temperature exceeding 25°C or humidity exceeding 60% - such dew deposition is not the appliance's fault.

In the Food Display Counter the evaporator's defrosting process is performed in cycles the Counter is brought to a standstill approximately every 6 hours. During the defrosting process water outflows in a PVC hose a container for collecting the water must be provided. In working conditions difficult for the appliance (i.e. at excessive humidity of the atmosphere, overloading with goods), if the cooling efficiency significantly drops, there is a need for additional evaporator defrosting. On such an occasion press the button on the face plate of the temperature controller marked with the  symbol. A green LED with the "dF" sign, if turned on, signifies that the defrosting process is being carried out.

**IMPORTANT:**

- 1. Never apply any mechanic measures other than recommended by the manufacturer to accelerate the defrosting process.*
- 2. Never use any electric appliances other than recommended by the manufacturer inside the food storage compartment.*
- 3. Protect the cooling circuit from damaging.*

## 5. Maintenance

Regular maintenance of the appliance is to be performed by the user by means of:

- Washing the appliance periodically with warm water and washing agents adequate for washing dishes. In order to clean the area where the glass pane touches the sidewall, remove the grips holding the side glass pane. After cleaning mount the elements back in a reversed order. When removing and mounting the elements back, exercise special care. Never use sharp instruments to remove dirt from the Counter's inside or outside surfaces.

**IMPORTANT! While washing the appliance, never leave the front glass pane tilting freely on the hinges. The glass pane may break on such an occasion, which is not subject to warranty. Never use cleaning agents containing chlorine or any other aggressive chemicals.**

- Cleaning the condenser in the refrigerating unit's chamber. First you need to remove the shield of the refrigerating unit's chamber. The condenser must be cleaned every three months by means of a hard brush and a vacuum cleaner. If the condenser gets very dirty in quicker time, perform the cleaning more often. Dirty condenser may result in overheating of the refrigerating unit and subsequently the appliance's failure that is not subject to warranty.

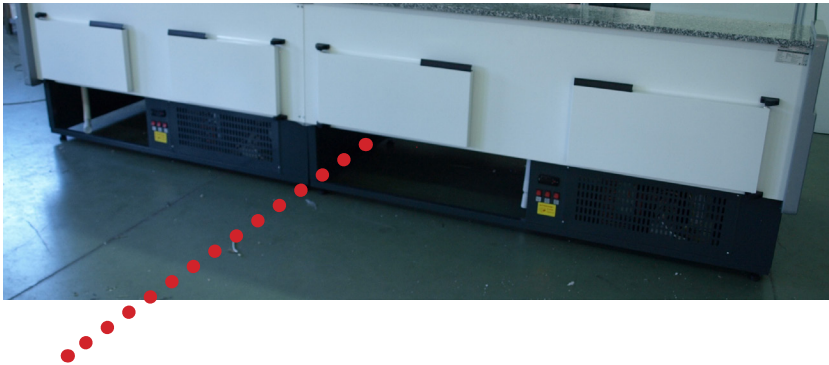

location of the condenser



The condenser should be cleaned at least once a months !!

---

## 6. Safety at work rules

- Replacing the fluorescent lamp. First remove the lamp's shield and then turn it by 90° and slide away from the grips. Replace the fluorescent lamp with an identical one. Reverse the above steps to mount the elements back

**IMPORTANT: The appliance must be disconnected from the power supply (remove the feeder cable from the electrical socket), before the washing, condenser cleaning and fluorescent lamp replacement operations are started.**

- On no account connect the appliance to power supply without the grounding protection.
- The electrical installation must be performed by an authorized electrician.
- Any repairs or adjustments in the electrical or cooling circuit may be performed exclusively by an authorized wireman.
- In the event any failures or defects are determined, such as sparking, breakdown, etc., disconnect the appliance from the power supply by removing the feeder cable's plug from the electrical socket and consult an electrician for a remedy.
- If the feeder cable needs replacing, the new one must be of the same type. The operation must be performed by an authorized electrician.
- Wash and clean the appliance only when it is disconnected from the power supply.
- Remember to clean the condenser and empty the drip container regularly

Do not:

- Fill the Confectionery Display Counter with goods before it cools down.
- Overload the CDC with excessive volume and weight of goods.
- Fill the CDC with warm or hot products.

Note: The used-up elements discard in compliance with applicable regulations.

## 7. Carel thermostat

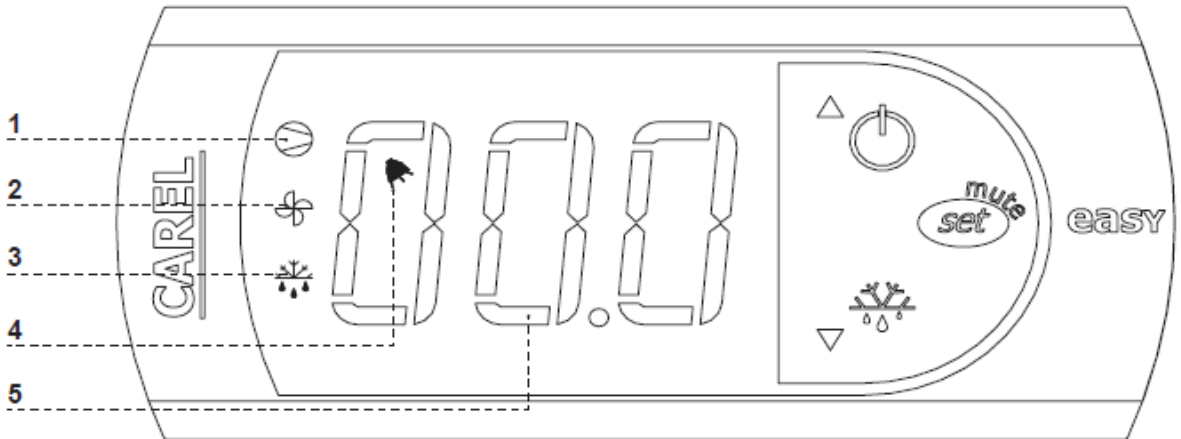

### WHAT DO DIODES ON CONTROL PANEL SIGNIFY

Diode 1 is on - Compressor: the symbol is visible when the compressor is working. It is blinking when compressor actuation is delayed by security procedure. It blinks in the following cycle: two blinks – pause, when the constant working mode is activated.





Diode 2 is on - Ventilator: the symbol is visible when evaporator ventilators are turned on. It blinks when the actuation of the ventilators is delayed by external disengagement or when another procedure is in progress.

Diode 3 is on - Defrosting: the symbol is visible when the defrosting function is activated. It blinks when the actuation is delayed by external disengagement or when another procedure is in progress.



Diode 4 is on - Alarm: the symbol is visible when the alarm is activated.

5 – current temperature inside the device is displayed (decimal places displayed after the comma)

### SETTING THE DESIRED TEMPERATURE

- press for 1 second  leading value shall be displayed on the screen;
- increase or decrease the leading value by means of  and , switches, until the desired value shall be obtained
- press  once again in order to confirm the new value of the setting point;

### MANUAL INPUT OF THE DEFROSTING CYCLE

Defrost  shall be realised in an automatic mode. It is possible to force defrosting at any moment by pressing and holding the  switch for minimum 5 seconds. Diode No. 1 shall blink during manual defrosting

## 8 MAXIMUM LEVEL OF GOODS IN DEVICE



Logotype defining the maximum stocking level of the device.



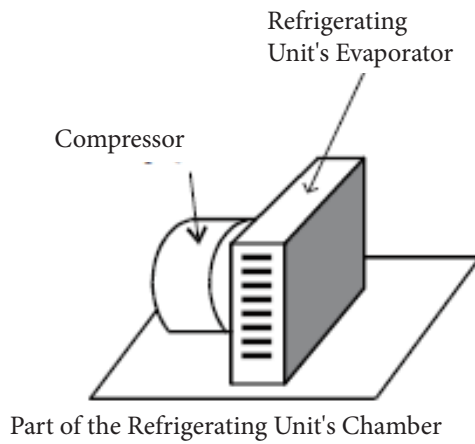
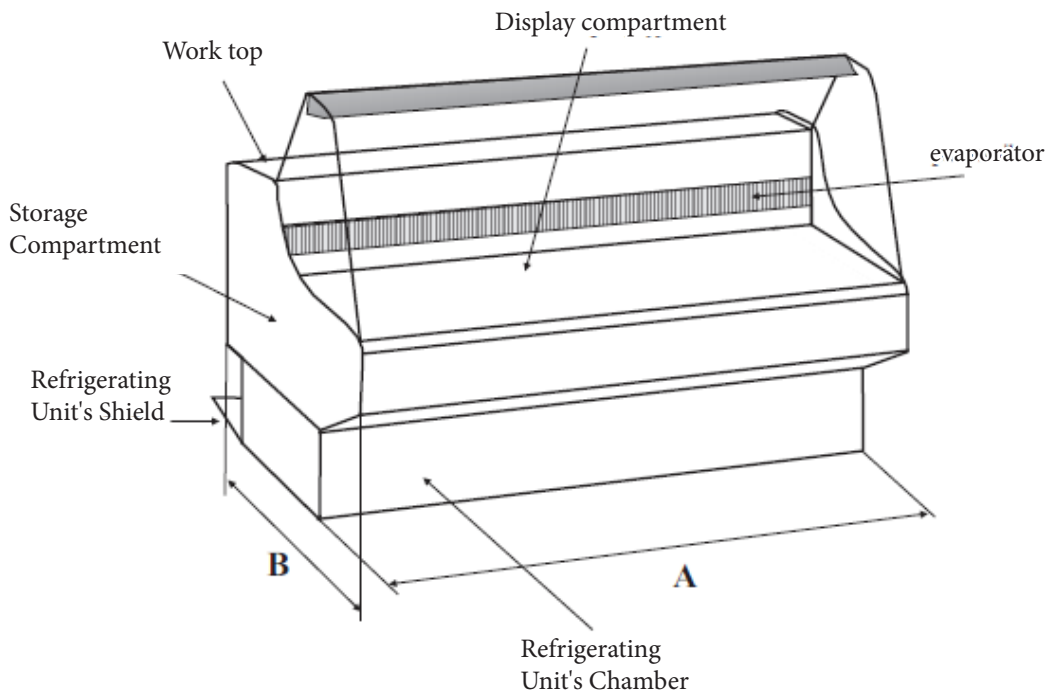

Rys. 1

9 TECHNICAL DRAWING

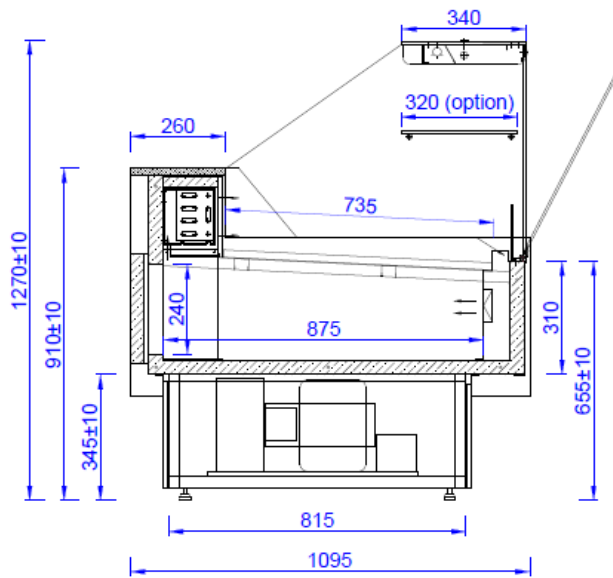
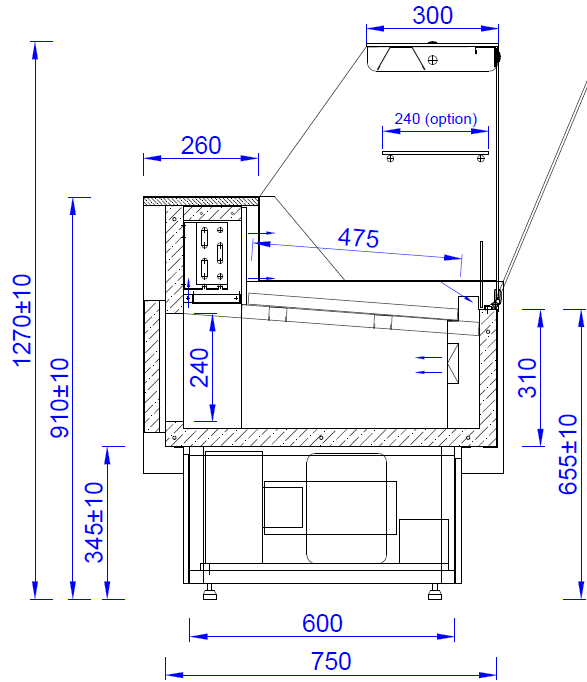

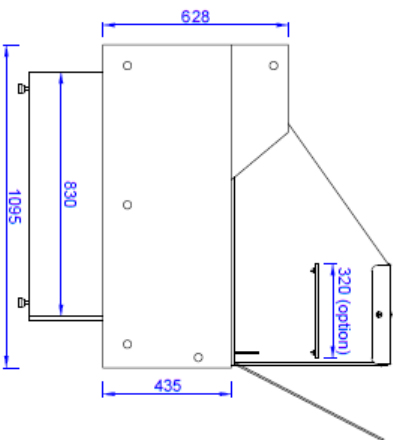
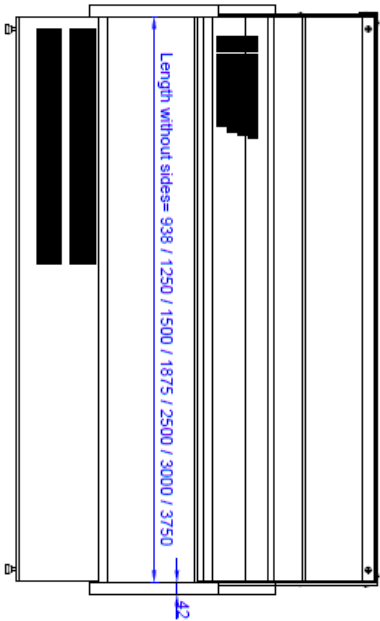
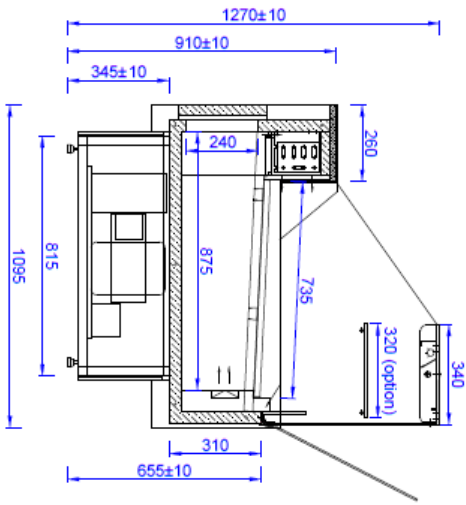

WC H ES BS 1.1

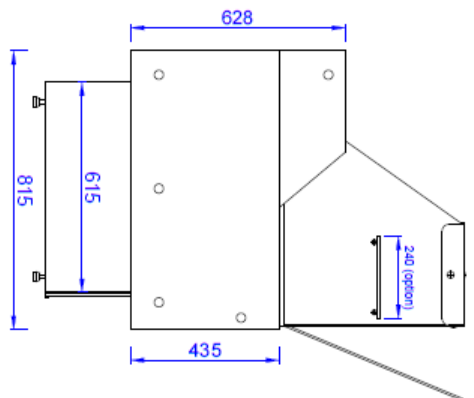
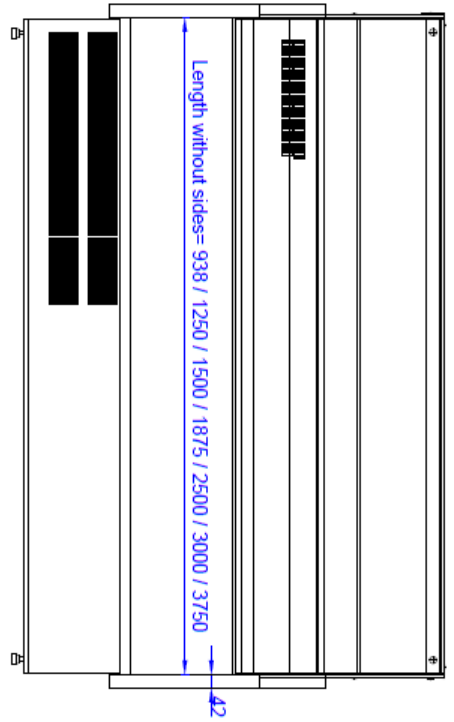
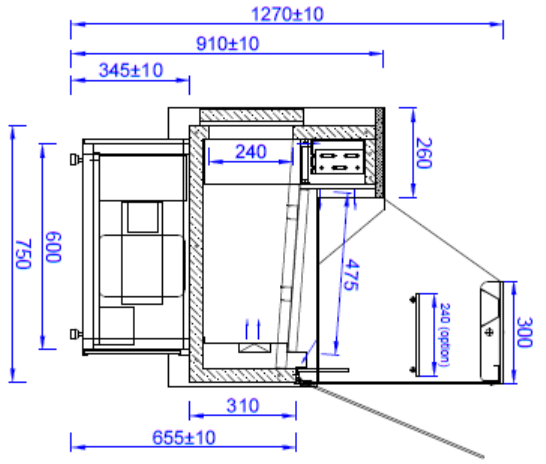

WC H ES BS 08

